

Hymson Laser

Metal Intelligent Equipments Product
海目星激光钣金智能装备



地址:广东省江门市蓬江区金桐八路18号
江苏省常州市金坛区金坛大道66号
网址:www.hymson-laser.com 全国销售热线:400-804-3288

 www.hymsonlaser.net  info@hymson.com

 Hymson Laser  Hymson Laser  Hymson Laser



Hymson
海目星激光
股票代码:688559

激光及自动化综合解决方案提供商
The provider of laser & automatic integrated solution

Hymson
CONTENTS 目录

改变世界装备格局 推动人类智造进步

Your Reliable Partner We Grow Together



01/ 企业篇 INTRODUCTION

公司介绍/Company Introduction 01

发展历程/Development History 03

02/ 产品篇 PRODUCTS

光纤激光切割机/Fiber Laser Cutting Machine 05

管材激光切割机/Tube Laser Cutting Machine 15

三维激光切割机/3D Laser Cutting Machine 25

板管一体激光切割机/Metal sheet&tube Laser Cutting Machines 27

卷材柔性切割生产线/Laser Coil Cutting Machine 29

激光切割柔性生产线/Flexible Machining System 31

激光焊机/Laser Welding Machine 35

03/ 服务篇 SERVICE

贴心服务/Considerate Service 37

服务网络/Service Network 39

企业介绍

COMPANY INTRODUCTION

HYMSON

海目星(股票代码:688559)成立于2008年,一直以来深耕激光和自动化领域,现已成为业界领先的激光和自动化装备综合解决方案提供商,是国家高新技术企业。

海目星激光一直关注光纤激光钣金应用市场,并成立了激光钣金智能装备事业部。经过十多年的潜心钻研,海目星激光积累了厚实的激光切割技术,拥有成熟的自动化制造经验。并针对不同行业的钣金应用,为用户提供专业及高品质的产品组合和服务,包括激光板材切割智能装备、激光管材切割智能装备、激光焊接和打标智能装备和激光自动化软件等综合性激光自动化解决方案。广泛应用于工程机械、建筑机械、轻工机械、智能家居、厨卫五金、电气装备、汽车制造、航空航天、石油机械等行业。服务网络辐射全国各省市以及海外各国家和地区。

Hymson Laser was founded in 2008 with a mission to design valuable integrated laser and automation solutions for customers. As one of the largest producers of laser intelligent technologies in China, Hymson Laser is a leading supplier of automation systems for new energy automobile, consumer electronics and metal fabrication industries.

Hymson Laser has been paying attention to the fiber laser sheet metal application market, and established the sheet metal intelligent equipment division. After years of research and development, Hymson Laser has accumulated solid laser cutting technology and has mature automated manufacturing experience. And for sheet metal applications in different industries, We provide users with professional and high-quality product portfolio and services, including comprehensive laser automation solutions such as laser plate cutting intelligent equipment, laser tube cutting intelligent equipment, laser welding intelligent equipment, marking intelligent equipment, and laser automation software.

Our current customers are experienced experts in varies of industry, such as sheet metal, engineering machinery, construction, smart furniture, bathroom & kitchen hardware, electric equipment, automobile, aviation and petroleum industry. The service network covers all provinces and cities in China and countries and regions in the world.



注册资本4亿
Registered Capital
of 400 million



子公司5家
5 Subsidiaries



员工4000多人
Over 4000
Employees



专利技术数百项
Hundreds
of Patents



合作企业数千家
Thousands of
Cooperative Enterprises

发展历程 DEVELOPMENT HISTORY



海目星激光成立
国内首台便携式激光机问世
Establishment of Hymson
Publishing of portable laser machine

2008



广州海目星成立
首台板材激光切割机问世
Establishment of Guangzhou Hymson
Publishing of sheet laser cutting machine

2010



鞍山海目星成立
Establishment of Anshan Hymson

2013



年度创新技术产品金球奖
Golden ball award of annual innovative technical products

2016

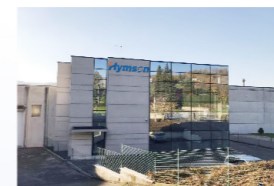

组建意大利研发团队
Formation of Italian R & D team

2018



科创板成功上市
Company Listing

2020



2009

国内首台蚀刻模板
激光机问世
Publishing of etching
template laser machine



2012

中国创新创业大赛二等奖
深圳第一名
Second prize of Innovation and
Entrepreneurship Competition in China
First place in Shenzhen



2015

新能源行业专用设备问世
Publishing of dedicated
device in new energy industry



2017

江门海目星成立
江苏海目星成立
Establishment of Jiangmen Hymson
Establishment of Jiangsu Hymson



2019

美国海目星成立
意大利海目星成立
Establishment of U.S.A Hymson
Establishment of Italy Hymson



2022

荣获“知名品牌”称号
江门、江苏生产基地二期建设启动
Won the title of "famous brand"
Phase II construction of Jiangmen
and Jiangsu production bases started



YOUR RELIABLE PARTNER
WE GROW TOGETHER

星耀 HF·H

HF·H Series Fiber Laser Cutting Machine

光纤激光切割机

FIBER LASER CUTTING MACHINE

切割样品/Samples



应用材料范围:0.5~110MM不锈钢,0.5~70MM碳钢板,0.5~70MM铝板,0.5~35MM铜板,镀锌板,电解板和硅钢等多种金属板材切割。

Applicable Materials: Specially used for cutting 0.5~110MM stainless steel, 0.5~70MM carbon steel, 0.5~70MM aluminum, 0.5~35MM copper, as well as galvanized steel, electrolytic steel and silicon steel etc.

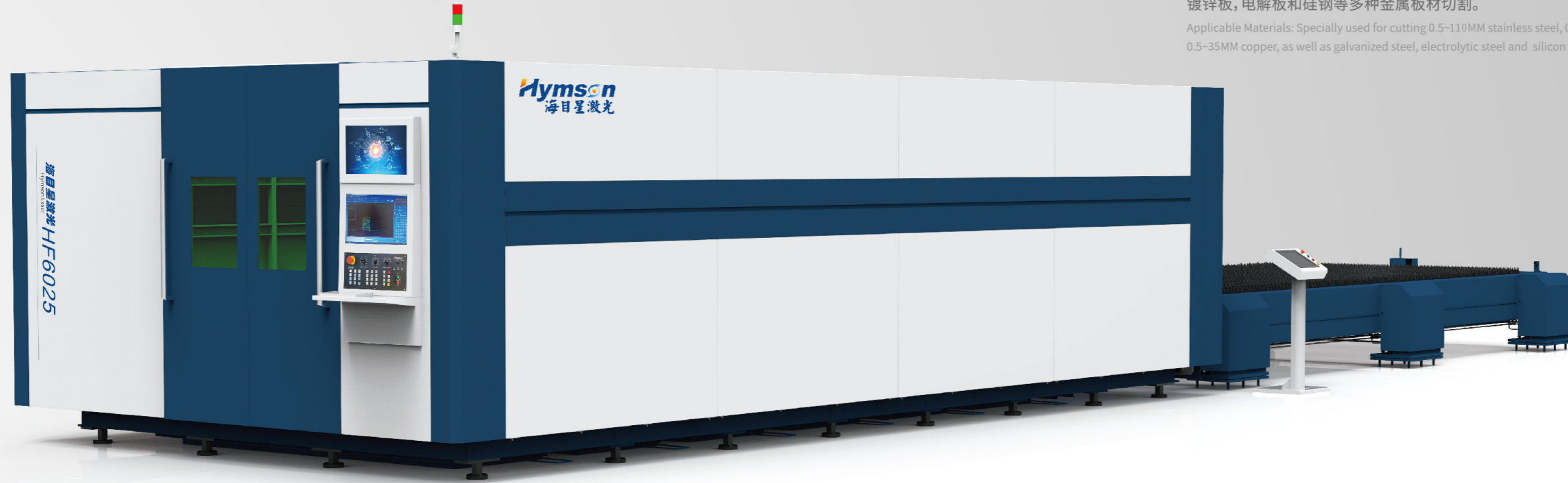

机型特点/Features

高强度高精度榫卯结构床身
High strength bed



高负载液压升降式交换工作平台
Elevating exchange table



满足大批量中厚板材自动化切割需求
Automatic cutting

- ① 激光上下料机器人
- ② 海目星激光切割机
- ③ 成品车
- ④ 插齿下料工装
- ⑤ 轨道定位台
- ⑥ 吸盘上料工装
- ⑦ 单张取料装置
- ⑧ 立体物料仓

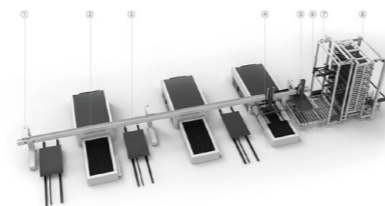

性能指标参数/Technical Specification

机型/Model	HF4020H	HF6025H
加工幅面 Processing area	4000mmX2000mm	6000mmX2500mm
激光器功率 Power	1500W-30000W	1500W-30000W
X/Y轴定位精度 X/Y axis positioning accuracy	±0.03mm/m	±0.03mm/m
X/Y轴重复定位精度 X/Y axis repeat positioning accuracy	±0.02mm	±0.02mm
X/Y轴最大定位速度 X/Y axis max. positioning speed	170m/min	170m/min
X/Y轴最大加速度 X/Y axis max. acceleration	1.0g	1.0g
工作台最大载重 Max. load of worktable	4t	6t
整机占地面积 Dimension(L*W)	10500mmX6400mm	15000mmX7000mm

星河 HF·T

HF·T series Extra Large Size Fiber Laser Cutting Machine

定制化大幅面激光切割机

EXTRA LARGE SIZE FIBER LASER CUTTING MACHINE

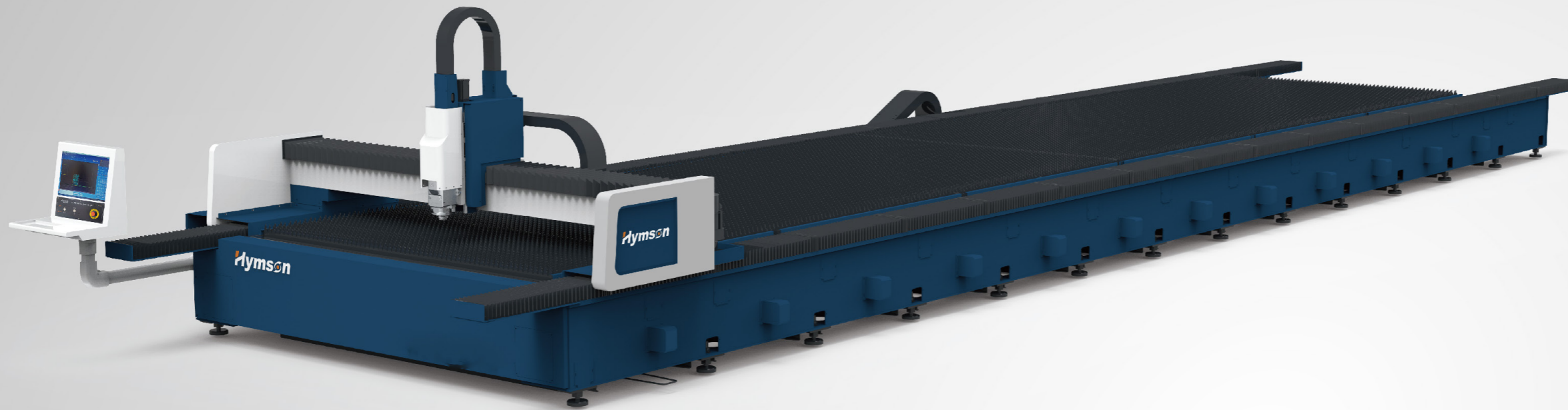

机型特点/Features

可定制超长超宽机型
Free customization

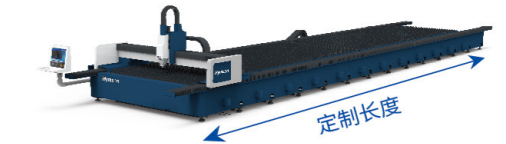

中空榫卯机床稳定热变形小
Hollow Structure Machine Tool

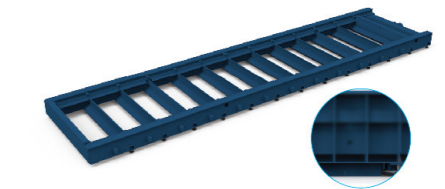

总线系统, 应用灵活自如
Control system

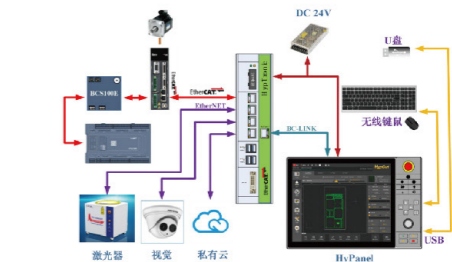

切割样品/Samples



应用材料范围: 0.5~70MM不锈钢, 0.5~50MM碳钢板, 0.5~50MM铝板, 0.5~25MM铜板, 镀锌板, 电解板和硅钢等多种金属板材切割。

Applicable Materials: Specially used for cutting 0.5~70MM stainless steel, 0.5~50MM carbon steel, 0.5~50MM aluminum, 0.5~25MM copper, as well as galvanized steel, electrolytic steel and silicon steel etc.

性能指标参数/Technical Specification

机型/Model	HF6025	HF8025	HF12025	HF24030	幅面定制
加工幅面 Processing area	6000mmX2500mm	8000mmX2500mm	12000mmX2500mm	24000mmX3000mm	25~50m
激光器功率 Power	6000W~40000W	6000W~40000W	6000W~40000W	6000W~40000W	6000W~40000W
X/Y轴定位精度 X/Y axis positioning accuracy	±0.03mm/m	±0.03mm/m	±0.1mm/m	±0.1mm/m	±0.1mm/m
X/Y轴重复定位精度 X/Y axis repeat positioning accuracy	±0.05mm	±0.05mm	±0.05mm	±0.05mm	±0.05mm
X/Y轴最大定位速度 X/Y axis max. positioning speed	110m/min	110m/min	100m/min	100m/min	100m/min
X/Y轴最大加速度 X/Y axis max. acceleration	0.8g	0.8g	0.8g	0.8g	0.8g
整机占地面积 Dimension(L*W)	8300mmx3500mm	10000mmx3500mm	15000mmx3500mm	31000mmx9000mm	根据幅面

星舰 HF·D

HF·D Series Fiber Laser Cutting Machine

光纤激光切割机

FIBER LASER CUTTING MACHINE



切割样品 / Samples



应用材料范围: 0.5~60MM 不锈钢, 0.5~60MM 碳钢板, 0.5~50MM 铝板, 0.5~20MM 铜板, 镀锌板, 电解板和硅钢等多种金属板材切割。

Applicable Materials: Specially used for cutting 0.5~25MM stainless steel, 0.5~25MM carbon steel, 0.5~25MM aluminum, 0.5~12MM copper, as well as galvanized steel, electrolytic steel and silicon steel etc.

机型特点 / Features

榫卯式结构升级机床
Tenon and mortise structure bed



热效动态补偿技术
Dynamic compensation technology

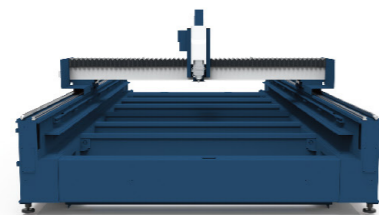

智能分区抽风系统
Exhaust system



性能指标参数 / Technical Specification

机型/Model	HF3015D	HF4020D	HF6020D	HF6025D	HF8025D	HF12025D	HF15025D
加工幅面 Processing area	3000mmX1500mm	4000mmX2000mm	6000mmX2000mm	6000mmX2500mm	8000mmX2500mm	12000mmX2500mm	15000mmX2500mm
激光器功率 Power	1500W-15000W	1500W-15000W	1500W-15000W	1500W-15000W	1500W-15000W	1500W-15000W	1500W-15000W
X/Y轴定位精度 X/Y axis positioning accuracy	±0.03mm/m	±0.03mm/m	±0.03mm/m	±0.03mm/m	±0.03mm/m	±0.03mm/m	±0.03mm/m
X/Y轴重复定位精度 X/Y axis repeat positioning accuracy	±0.02mm	±0.02mm	±0.02mm	±0.02mm	±0.02mm	±0.02mm	±0.02mm
X/Y轴最大定位速度 X/Y axis max. positioning speed	140m/min	140m/min	140m/min	140m/min	140m/min	140m/min	140m/min
X/Y轴最大加速度 X/Y axis max. acceleration	1.5g	1.2g	1.2g	1.0g	1.0g	0.8g	0.8g
工作台最大载重 Max. load of worktable	0.8t	1.0t	2.6t	3.0t	4.0t	6.0t	7.5t
整机占地面积 Dimension(L*W)	8330mmX5700mm	10500mmX5900mm	15000mmX6400mm	15000mmX7000mm	20000mmX7000mm	30000mmX7000mm	30000mmX7000mm

星锐 HF·C

HF·C Series Fiber Laser Cutting Machine

光纤激光切割机

FIBER LASER CUTTING MACHINE

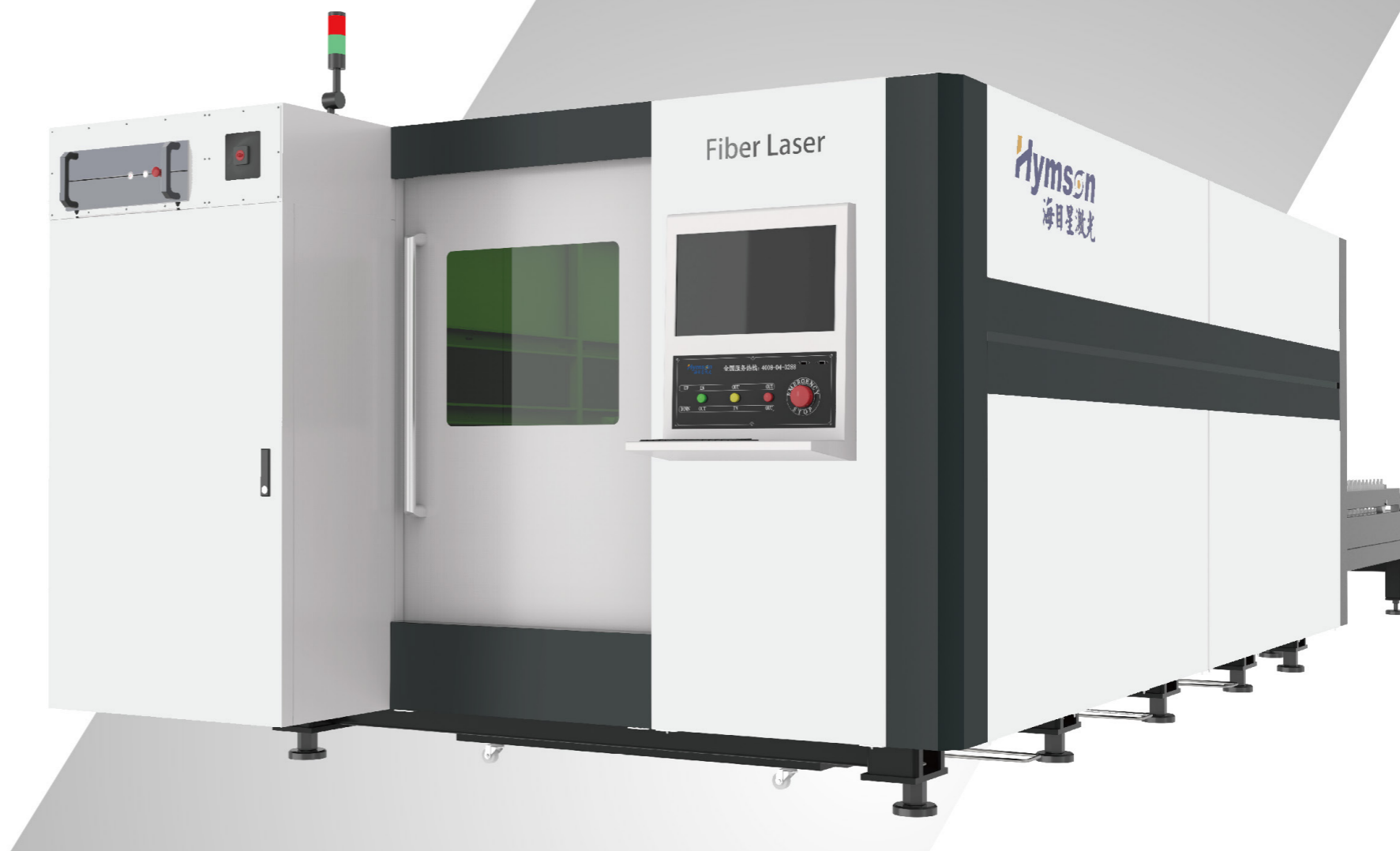

切割样品 / Samples

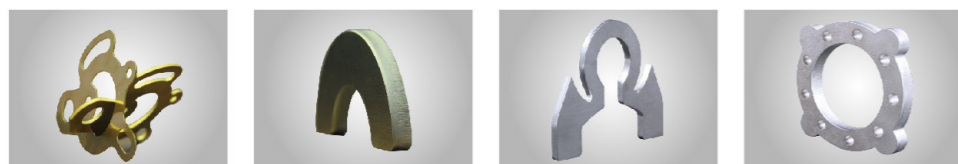

应用材料范围: 0.5~30MM不锈钢, 0.5~30MM碳钢板, 0.5~30MM铝板, 0.5~15MM铜板, 镀锌板, 电解板和硅钢等多种金属板材切割。

Applicable Materials: Specially used for cutting 0.5~30MM stainless steel, 0.5~30MM carbon steel, 0.5~30MM aluminum, 0.5~15MM copper, as well as galvanized steel, electrolytic steel and silicon steel etc.

机型特点 / Features

榫卯结构床身
Tenon and mortise structure bed



高强度拉制铝横梁
Drawn aluminium beams

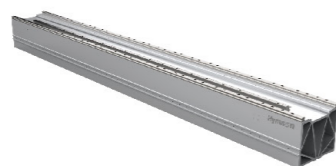

中薄板低成本、高效率切割
Low-cost, high-efficiency cutting

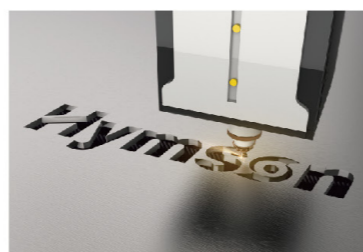

性能指标参数 / Technical Specification

机型 / Model	HF3015C	HF4020C	HF6025C
加工幅面 Processing area	3000mmX1500mm	4000mmX2000mm	6000mmX2500mm
X/Y轴定位精度 X/Y axis positioning accuracy	±0.03mm/m	±0.03mm/m	±0.03mm/m
X/Y轴重复定位精度 X/Y axis repeat positioning accuracy	±0.02mm	±0.02mm	±0.02mm
X/Y轴最大定位速度 X/Y axis max. positioning speed	110m/min	110m/min	140m/min
X/Y轴最大加速度 X/Y axis max. acceleration	0.8g	0.8g	1.0g
工作台最大载重 Max. load of worktable	0.7t	1.0t	3.0t
整机占地面积 Dimension(L*W)	8700mmX5700mm	10800mmX6300mm	15000mmX7000mm

星辉 HF·A

HF·A Series Fiber Laser Cutting Machine

光纤激光切割机

FIBER LASER CUTTING MACHINE



切割样品 / Samples

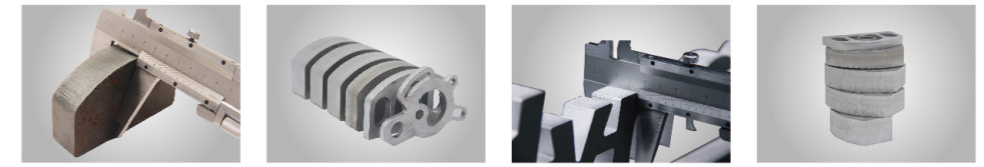

应用材料范围: 0.5~30MM 不锈钢, 0.5~30MM 碳钢板, 0.5~30MM 铝板, 0.5~15MM 铜板, 镀锌板, 电解板和硅钢等多种金属板材切割。

Applicable Materials: Specially used for cutting 0.5~30MM stainless steel, 0.5~30MM carbon steel, 0.5~30MM aluminum, 0.5~15MM copper, as well as galvanized steel, electrolytic steel and silicon steel etc.

机型特点 / Features

单平台, 灵活应用

Single platform, flexible application

钣焊棒卯焊接床身

Welded Bed with Mortise-and-tenon Joint

可移动操作平台, 操作方便

Mobile workbench

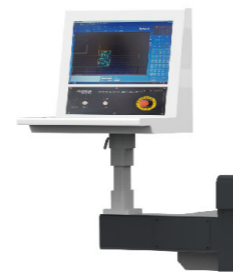

性能指标参数 / Technical Specification

机型 / Model	HF3015A	HF4020A	HF6020A
加工幅面 Processing area	3000mmX1500mm	4000mmX2000mm	6000mmX2000mm
激光器功率 Power	1500W-20000W	1500W-20000W	1500W-20000W
X/Y轴定位精度 X/Y axis positioning accuracy	±0.03mm/m	±0.03mm/m	±0.03mm/m
X/Y轴重复定位精度 X/Y axis repeat positioning accuracy	±0.02mm	±0.02mm	±0.02mm
X/Y轴最大定位速度 X/Y axis max. positioning speed	110m/min	110m/min	110m/min
X/Y轴最大加速度 X/Y axis max. acceleration	0.8g	0.8g	0.8g
工作台最大载重 Max. load of worktable	0.9t	1.5t	2.8t
整机占地面积 Dimension(L*W)	5000mmX2500mm	6300mmX3000mm	8300mmX3000mm

定制型激光切管机

Customized Tube Laser Cutting Machine

TUBE LASER CUTTING MACHINE

切割样品/Samples

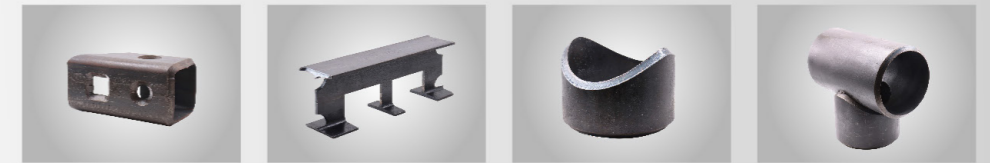

应用材料范围：碳钢或不锈钢圆管Φ10MM~Φ350MM，方管与矩形管□10MM~□250MM，腰圆管和椭圆管，槽钢，角钢等异型管材切割。

Applicable Materials: Specially used for cutting Φ10MM~Φ350MM carbon steel and stainless steel round pipe, □10MM~□250MM carbon steel and stainless steel square pipe, waist-shaped pipe, oval pipe etc.



机型特点/Features

定制三卡盘、四卡盘等
Free custom chuck

模块化设计，定制不同长度
Customize different lengths

全自动重管上料
Automatic loading of heavy tube

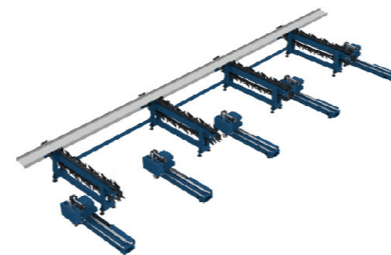
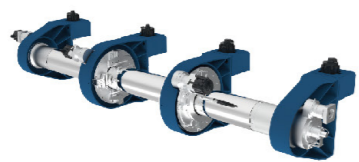

性能指标参数/Technical Specification

机型/Model	TP6026	FP12035
加工管材范围 Tube processing area	圆管 Φ20mm~Φ260mm、方管与矩形管 □20mm~□180mm	圆管 Φ20mm~Φ350mm、方管与矩形管 □20mm~□250mm
激光器功率 Power	3000W-6000W	3000W-6000W
切割余料长度 The length of the remaining	≥0mm	≥0mm
A,B轴 / 无限旋转 Infinite rotating of A, B axis	100rpm/min	60rpm/min
上料长度 Loading length	6000mm	12000mm
最大单管重量 Max. path weigh	360kg	1.2t
整机占地面积 Dimension(L*W)	16000mm×4000mm	26000mm×5000mm

X7 X7 Series Tube Laser Cutting Machine

管材激光切割机

TUBE LASER CUTTING MACHINE

切割样品/Samples

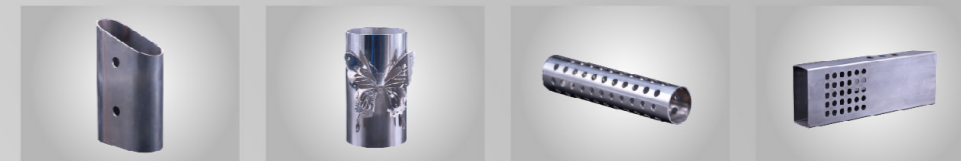

应用材料范围:碳钢或不锈钢圆管Φ15MM~Φ220MM, 方管与矩形管□15MM~□150MM, 腰圆管和椭圆管, 槽钢, 角钢等异型管材切割。

Applicable Materials: Specially used for cutting Φ15MM~Φ220MM carbon steel and stainless steel round pipe, □15MM~□150MM carbon steel and stainless steel square pipe, waist-shaped pipe, oval pipe etc.



机型特点/Features

全自动高标准专业激光切管机
High standard

海目星专利全自动上料系统
Fully automatic feeding

丰富检测功能
Detection function

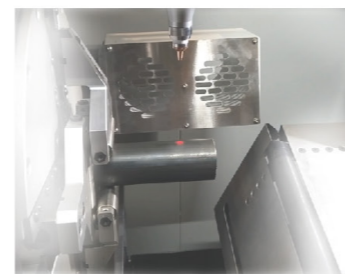

性能指标参数/Technical Specifaion

机型/Model	X7-6012PRO	X7-6022PRO	X7-6022Plus	X7-6035PRO
加工管材范围 Tube processing area	Φ10mm-Φ120mm, □10mm-□80mm	Φ10mm-Φ220mm, □10mm-□150mm	Φ10mm-Φ220mm, □10mm-□150mm	Φ20mm-Φ350mm, □20mm-□250mm
激光器功率 Power	1000W-3000W	1000W-3000W	1000W-3000W	1000W-3000W
坡口切割 Bevel cutting	无	无	坡口	无
A,B轴无限旋转 Infinite rotating of A, B axis	150rpm/min	100rpm/min	100rpm/min	60rpm/min
最大单管重量 Max. path weigh	150kg	300kg	300kg	1000kg
整机占地面积 Dimension(L*W)	12000mm×3000mm	12000mm×3000mm	12000mm×3000mm	13000mm×3500m

X6 X6 Series Tube Laser Cutting Machine

管材激光切割机

TUBE LASER CUTTING MACHINE

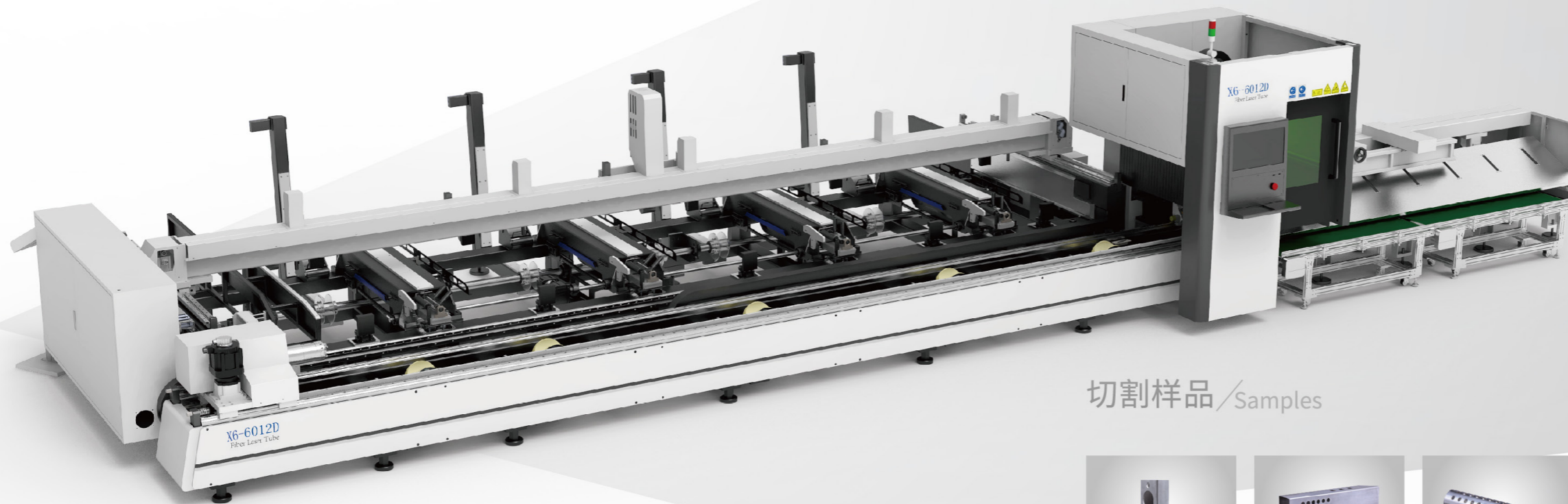

切割样品/Samples

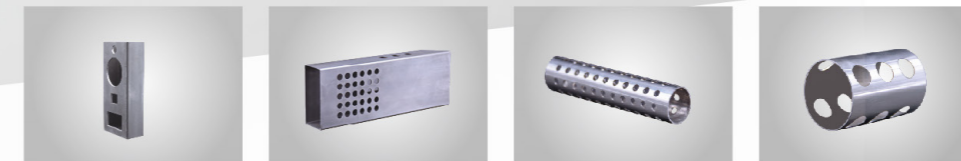

应用材料范围:碳钢或不锈钢圆管 Φ 15MM~ Φ 120MM, 方管与矩形管 \square 15MM~ \square 80MM, 腰圆管和椭圆管, 槽钢, 角钢等异型管材切割。

Applicable Materials: Specially used for cutting Φ 15MM~ Φ 120MM carbon steel and stainless steel round pipe, \square 15MM~ \square 80MM carbon steel and stainless steel square pipe, waist-shaped pipe, oval pipe etc.

机型特点/Features

加工范围大, 种类多
Free machining



短尾料, 材料利用率高
Material usage



伺服随动下料
Intelligent cutting

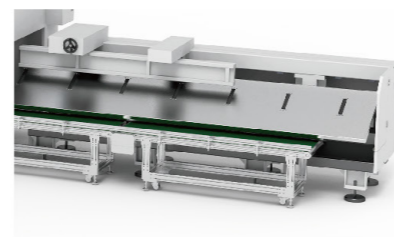

性能指标参数/Technical Specifaion

机型/Model	X6-6012D	X6-6022D	X6-6035D
加工管材范围 Tube processing area	Φ 10mm~120mm、 \square 10mm~ \square 80mm	Φ 10mm~220mm、 \square 10mm~ \square 150mm	Φ 20mm~350mm、 \square 20mm~ \square 250mm
激光器功率 Power	1000W-3000W	1000W-3000W	1000W-3000W
A,B轴无限旋转 Infinite rotating of A, B axis	150rpm/min	100rpm/min	60rpm/min
最大单管重量 Max. path weigh	150kg	300kg	1000kg
整机占地面积 Dimension(L*W)	12000mm \times 3000mm	12000mm \times 3000mm	13000mm \times 3500m

X5 X5 Series Tube Laser Cutting Machine

管材激光切割机

TUBE LASER CUTTING MACHINE

切割样品/Samples



应用材料范围: 碳钢或不锈钢圆管 Φ 20MM~ Φ 180MM, 方管与矩形管 \square 20MM~ \square 130MM, 腰圆管和椭圆管等多种异型管材。

Applicable Materials: Specially used for cutting Φ 20MM~ Φ 180MM carbon steel and stainless steel round pipe, \square 20MM~ \square 130MM carbon steel and stainless steel square pipe, waist-shaped pipe, oval pipe etc.



入门级专业激光切管机
Affordable Professional Laser Tube Cutting Machine



全自动气动全封闭卡盘
Fully enclosed chuck



MASTER6000T总线控制系统
Fully enclosed chuck

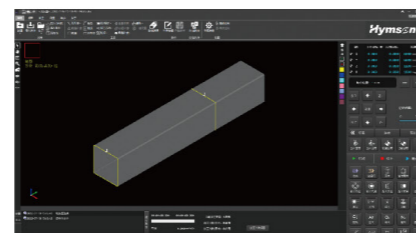

性能指标参数/Technical Specifaion

机型/Model	X5-6022D
加工管材范围 Tube processing area	6200mm x Φ 10mm~ Φ 220mm 6200mm x \square 10mm~ \square 150mm
激光器功率 Power	1000W-3000W
上料长度 Loading length	3000mm~6200mm
最大单管重量 Max. path weigh	300kg
整机占地面积 Dimension(L*W)	10000mm×2500mm

高速激光切管机

High Speed Tube Laser Cutting Machine

TUBE LASER CUTTING MACHINE

切割样品/Samples



应用材料范围: 碳钢或不锈钢圆管 ϕ 10mm~ ϕ 88mm, 方管与矩形管 \square 15mm~ \square 60mm, 腰圆管和椭圆管等多种管材切割。

Applicable Materials: Specially used for cutting ϕ 10MM~ ϕ 88 MM carbon steel and stainless steel round pipe, \square 15MM~ \square 60MM carbon steel and stainless steel square pipe, waist-shaped pipe, oval pipe etc.



机型特点/Features

高性能光纤激光器
Fiber Laser Generator



四爪中空回转气动卡盘
Pneumatic chuck

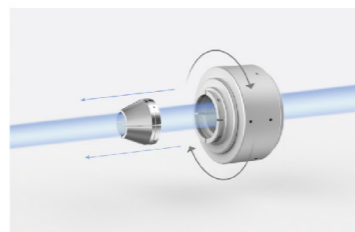

高速、高精度控制伺服电机
Servo motor



性能指标参数/Technical Specification

机型/Model	X1-368S	X2-468S	X3-568S
加工管材范围 Tube processing area	ϕ 10mm~88mm	ϕ 15mm~85mm、 \square 15mm~ \square 60mm	ϕ 15mm~85mm、 \square 15mm~ \square 60mm
激光器功率 Power	1000W~1500W	1000W~1500W	1000W~1500W
坡口切割 Bevel cutting	无	无	坡口
最大加速度 Max. acceleration	1.0g	1.2g	1.2g
上料长度 Loading length	2000mm~9000mm	4000/6200mm	4000/6200mm
设备重量 Weight of machine tool	800kg	2600kg	2600kg
整机占地面积 Dimension(L*W)	7980mmx1630mm	9500mmx2200mm	9500mmx2200mm

三维激光切割机

3D LASER CUTTING MACHINE

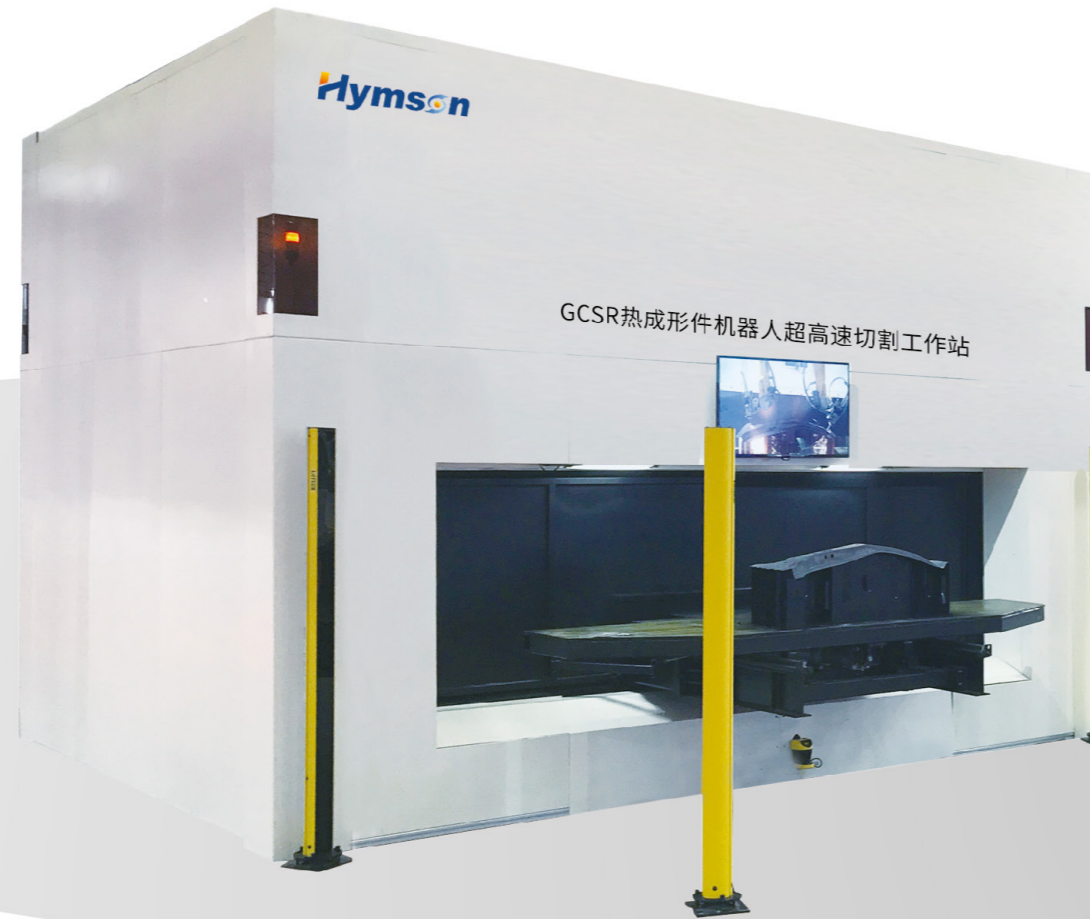

切割样品/Samples



机型特点/Features

机器人二次校准提高机器人定位精度
Robot secondary calibration

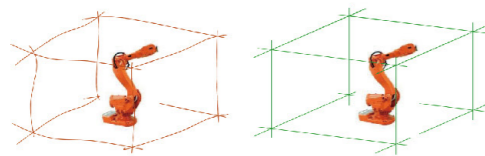

运动插补算法提高小圆切割精度
Motion Interpolation Algorithm

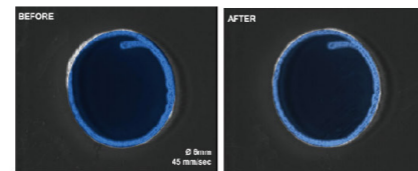

机器人多轴联动功能开发实现复杂工件的高效切割
Robotic multi-axis linkage

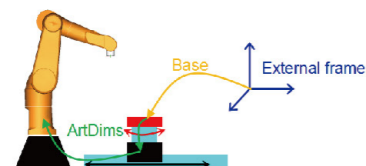

TCP值自动校准功能实现批量生产的纠错
Automatic calibration of TCP values

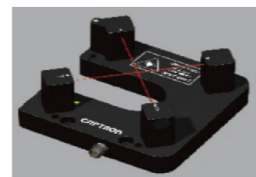

性能指标参数/Technical Specification

机型/Model	GCSR
单机器人加工范围 Processing range	φ3600mm
激光器输出功率 Output Power	1500W-3000W
切割小圆精度 Small circle accuracy	±0.05mm
切割轨迹精度 Track accuracy	±0.1mm
转台直径 Turntable diameter	φ3700mm
旋转台交换时间 Exchange time	3.5-5s
最快切割速度 Maximum cutting speed	15m/min

HF·BP

HF·BP Series Fiber Laser Cutting Machine

板管一体激光切割机

METAL SHEET&TUBE LASER CUTTING MACHINES



切割样品/Samples

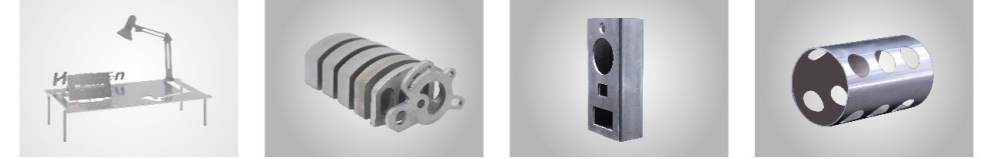

+碳钢或不锈钢圆管 $\Phi 20\text{mm} \sim \Phi 165\text{mm} / \Phi 219\text{mm}$ 、
方管与矩形管 $\square 20\text{mm} \sim \square 120\text{mm} / \square 150\text{mm}$ ，椭圆管等管材
Applicable Materials: Circular tubes $\Phi 20\text{mm} \sim \Phi 165\text{mm} / 219\text{mm}$
square tubes and rectangular tubes $\square 20\text{mm} \sim \square 120\text{mm} / 150\text{mm}$

机型特点/Features

切板、切管一机两用
Multi-purpose machine

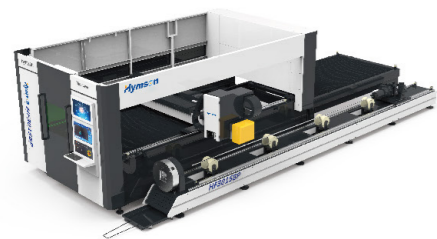

高效率的激光切板、切管
High production efficiency of pipe cutting



专业激光切割系统
Professional laser cutting system

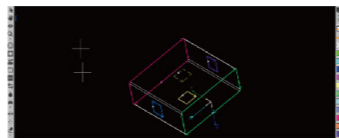

性能指标参数/Technical Specification

机型/Model	HF3015BP
— 板材激光切割 Sheet laser cutting —	
加工幅面 Processing area	3000mmX1500mm
激光器功率 Power	1000W-6000W
X/Y轴定位精度 X/Y axis positioning accuracy	$\pm 0.03\text{mm/m}$
X/Y轴重复定位精度 X/Y axis repeat positioning accuracy	$\pm 0.02\text{mm}$
X/Y轴最大定位速度 X/Y axis max. positioning speed	110m/min
X/Y轴最大加速度 X/Y axis max. acceleration	0.6g
工作台最大载重/个 Max. load of worktable	0.8t
— 管材激光切割 Tube laser cutting —	
加工管材范围 Tube processing area	$\Phi 20\text{mm} \sim \Phi 165\text{mm} / \Phi 219\text{mm}$ $\square 20\text{mm} \sim \square 120\text{mm} / \square 150\text{mm}$
上料长度 Loading length	3000mm~6200mm
下料长度 Unloading length	0~3000mm
最大单管重量 Max. path weigh	33Kg/m
设备总重量 Weight of machine tool	10t
整机占地面积 Dimension(L*W)	9000mmX4700mm

星越HF-TU全自动卷材柔性切割生产线

LASER COIL CUTTING MACHINE

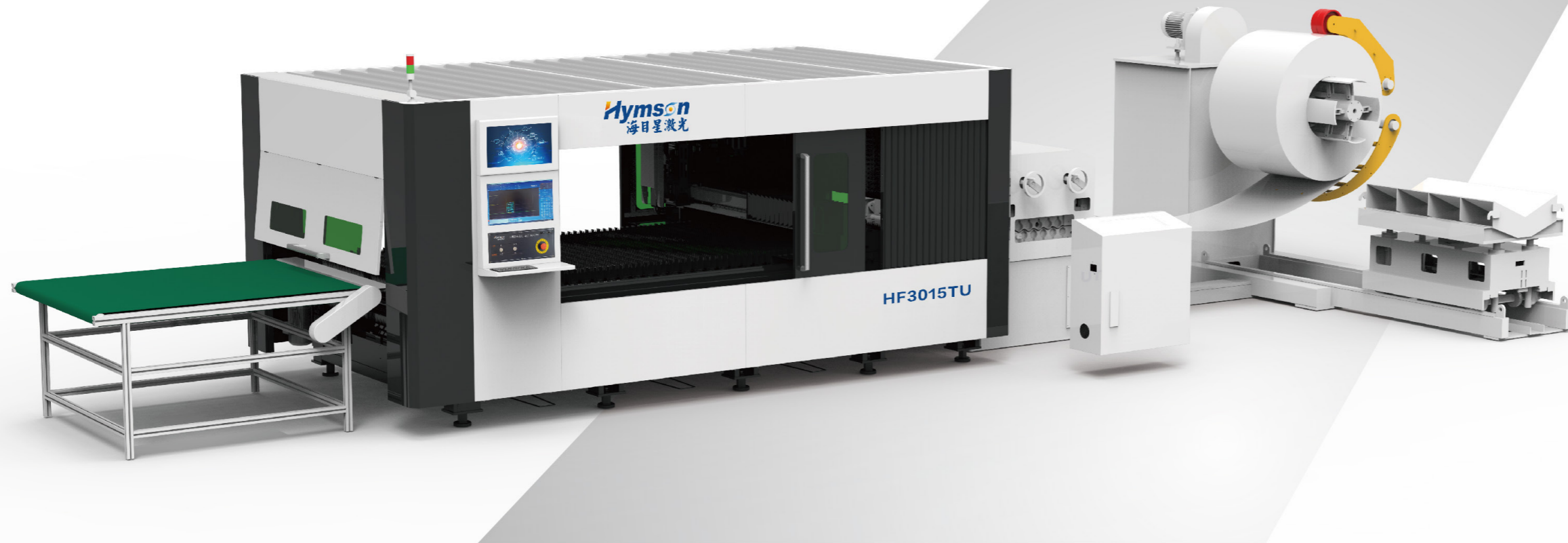

机型特点/Features

一体化自动生产线
Integrated Automatic Production Line

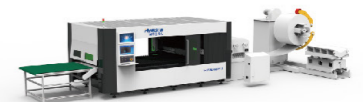

整平送料机
Leveling Feeder

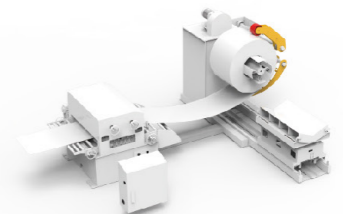

下料单元
Blanking Unit



切割样品/Samples



应用材料范围: 不锈钢、碳钢、锰钢、镀锌板、各种合金板、稀有金属等2mm以下各类薄金属卷料。

Applicable Materials: various thin metal coils within 2mm of stainless steel, carbon steel, manganese steel, galvanized sheet, various alloy sheets, rare metals, etc.

性能指标参数/Technical Specification

机型/Model	HF3015TU
X/Y轴定位精度 X/Y axis positioning accuracy	±0.03mm/m
X/Y轴重复定位精度 X/Y axis repeat positioning accuracy	±0.02mm
X/Y轴最大加速度 X/Y axis max. acceleration	1.0 g
X/Y轴最大定位速度 X/Y axis max. positioning speed	140m/min
Z轴最大加速度 z axis max. acceleration	1.0g
设备总重量 Weight of machine tool	8t
主机占地尺寸 Dimension(L*W)	8330mmX5700mm

平板激光切割全自动上下料系统

AUTOMATIC LOADING & UNLOADING SYSTEMS

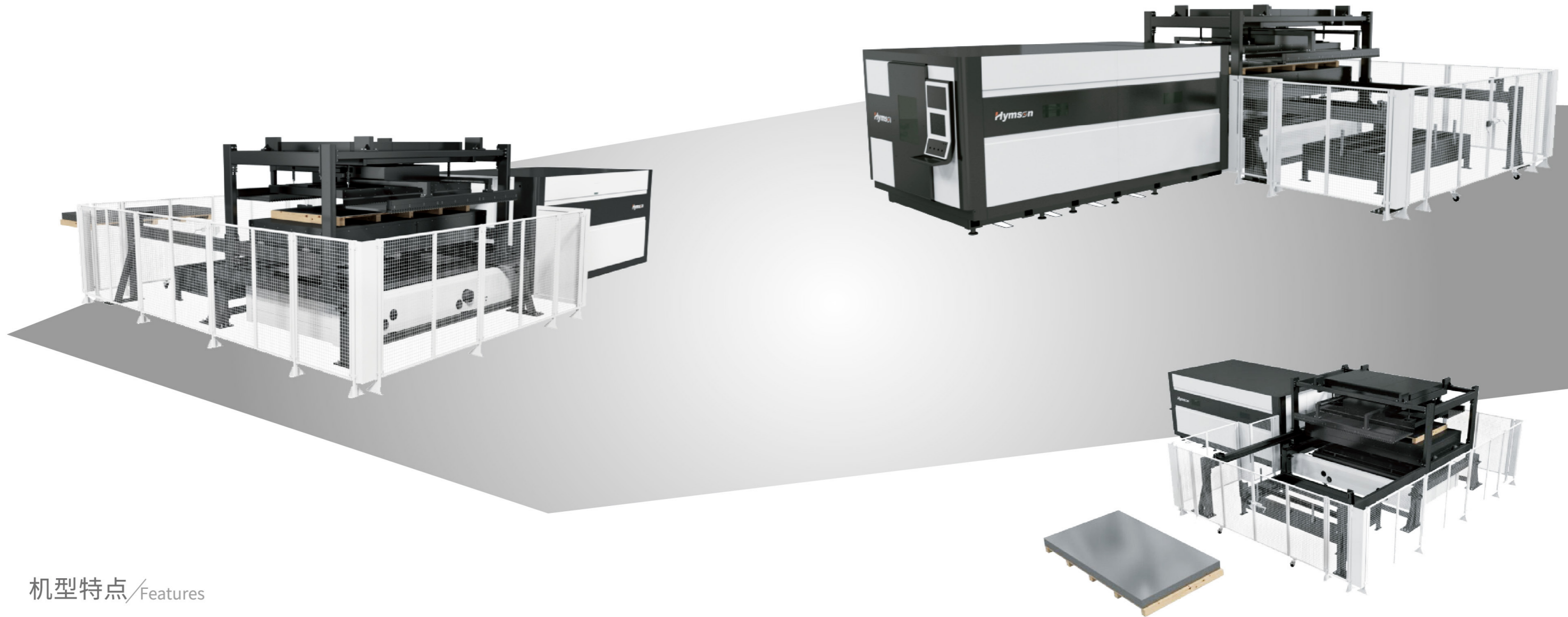

机型特点/Features

无人候上料和下料
Automatic loading & unloading

大批量自动化生产
High-volume automated production

节约时间和人力成本, 高效益
Operation saves considerable time

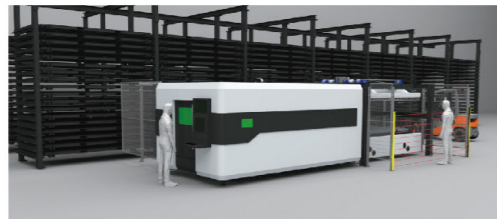

激光切管自动上料系统

LOADING SYSTEM OF LASER TUBE CUTTING MACHINE



全自动上料系统
Fully automatic loading system



小批量上料系统
Small batch loading system

性能指标参数 / Technical Specifaion

上料长度 Loading length	3000mm ~6200mm
加工管材范围 Tube processing area	Φ15mm~Φ350mm、□15mm~□350mm根据不同型号配置 (Configure according to different models)
管型 Material type	圆管、方管与矩形管 (Round, square and rectangular tubes)
占地面积 Area	根据不同型号配置 (Configure according to different models)

手持激光焊接机

HANDHELD LASER WELDING MACHINE

完美取代传统氩弧焊、电焊在薄板不锈钢板、铁板、铝板等金属材料方面焊接;焊缝美观,速度快,无焊痕,无变色,无需后期打磨;操作简易上手、对操作人员要求极低。

Innovated technology for replacement of traditional argon arc welding and electric welding, suitable for such thin material as stainless steel, mild steel, aluminum alloy etc. Perfect weld-seam, fast speed, no welding marks, no discoloration after welding and simply operation.



机型特点/Features

手持摆动焊接头
Holding Swing Welding Joint



送丝系统
Wire Loading System



精密板卡
Precision PCB Board

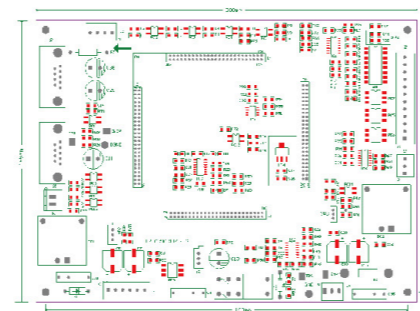

性能指标参数/Technical Specifaicon

机型/Model	MW
激光器功率 Power	800W-2000W
波长 Wavelength	1080nm
光束质量 Beam quality	2.8m ²
输出光纤长度 Feeding fiber cable length	10m
输出光纤直径 Feeding fiber core diameter	50 μm
准直 Collimating focal length	80mm
聚焦 Focusing focal length	150mm
冷却方式 Cooling method	水冷 water
整机占地面积 Dimension(L*W*H)	960mmX525.5mmX1020.5mm

贴心服务 CONSIDERATE SERVICE



售后支持

After-sales Support

时刻在您身边的售后服务团队, 免费提供远程故障解除指导。使用专业安全的报修服务系统, 报修服务承诺24小时内工程师响应。

Our services team is always at disposal for providing free remote trouble-shooting; with our professional and safety Service Call System, we can respond to customer within 24 hours.

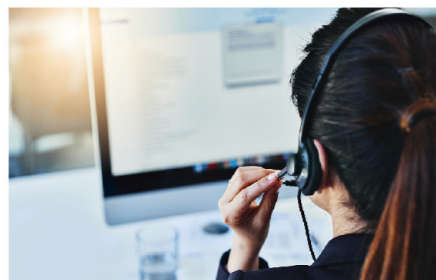

安装培训

Installation Training

免费为您提供设备安装服务及员工操作培训服务(激光原理、工艺应用、设备保养、安全知识、故障排查), 提供员工再培训及技术输送服务。

We offer the services for installation, commissioning and training (principles of laser, application, equipment maintenance, safety knowledge and trouble shooting), also re-training and technical support for our customers.



技术支持

Technical Support

专业的研发技术团队, 免费提供应用技术交流及行业应用解决方案, 提供硬件和软件升级服务。

Our professional R & D technical team provides free application technology communication and industry application solutions, as well as hardware and software upgrade services.



复产支持

Restoration Support

配备充足的备件支持服务, 确保维修期间不受影响, 以最短时间恢复生产。

Equipped with sufficient spare parts support services to ensure that it will not be affected during maintenance and resume production in the shortest time.



客服专员

Customer Service Executive

专员专管的一站式客户服务, 全天12小时为您提供各项咨询及需求服务。

The one-stop customer service managed by the commissioner provides you with various consultation and demand services 12 hours a day.

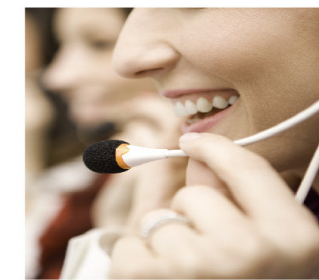

中国区服务网络示意图

CHINA DOMESTIC SERVICE NETWORK

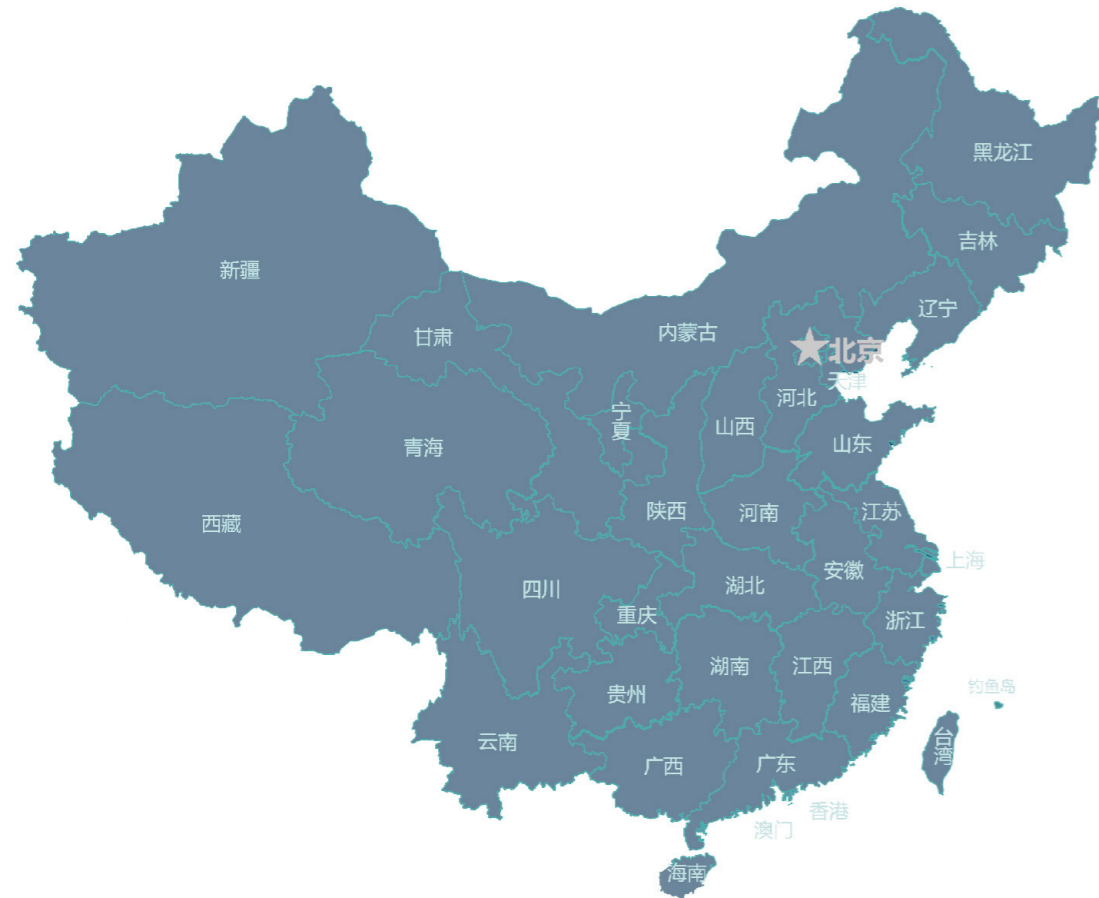

海目星激光的服务网络已经覆盖全国各省市地区
Hymson Laser services has covered all over the China

国外区域服务网络示意图

FOREIGN REGIONAL SERVICE NETWORK

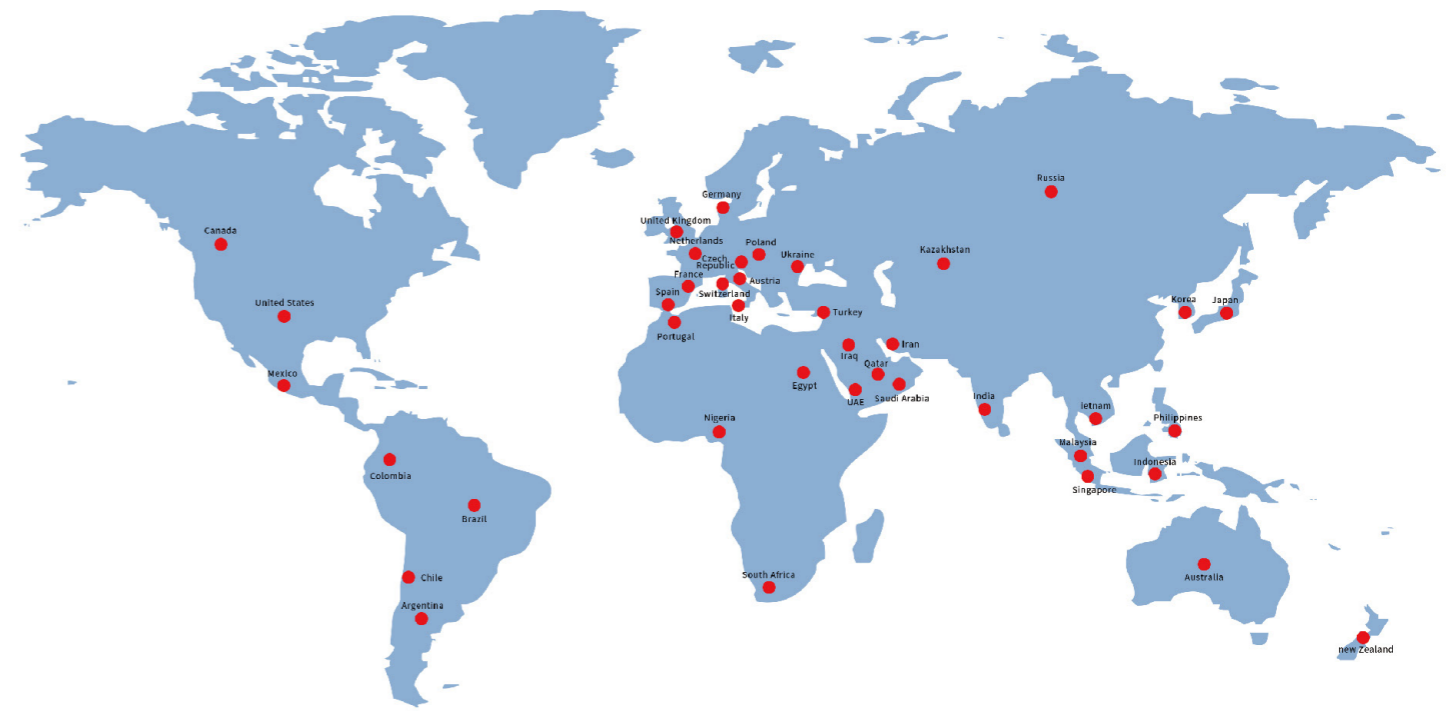

海目星激光全球服务网络已经遍及近40个国家和地区
Hymson Laser has completed services network in 40 countries over the world



海目星激光保留对机床尺寸、外观和装备的修改权,恕不通知
Hymson Laser remains the right of modification for the size of machine tool,the appearance and the equipment. No any Notifications.